

**NISSAN GROUP
OF NORTH AMERICA**



Level 1 vs Level 2 EVSE Energy Consumption of Production Electric Vehicles

**Zero Emission Technology Development
Nissan Technical Center North America
Eloi Taha**

March 12, 2020

Outline

- ❑ Background & Request & Study
- ❑ Preliminary Response of One OEM
- ❑ Test Setup
- ❑ Test Results
- ❑ Summary of Test Results & Conclusions

[Acknowledgement]

- I would like to thank Terry Grant Principal Technician at Nissan Technical Center North America (NTCNA) for his great support for this testing.
- Thanks also goes to Engineers Ansu Jammeh and Ernest Workman of Nissan ZEV Engineering group for their assistance with the test setup and discussions on the integration method.

Background, Request & Study

[Background]

- In March 2018, at the EPRI IWC meetings in Tempe, AZ, couple utilities have approached Nissan to obtain data of level 1 (L1) versus Level 2 (L2) EVSEs energy consumption when charging vehicles.
- The goal was to convince their respective State Energy Commissions to allocate more funds to install more L2 EVSEs than L1 ones. They needed data to justify such request.

[Utility Request]

- Utility companies would need OEM data that shows the magnitude of the constant electrical loads (any non HV battery load) per charging session.
- Something similar to the data below

| Constant Non-Battery Load | Do these loads cease once charging session is complete? |
|---------------------------|---|
| i.e. 317 Watts | Yes / No |

- Utility companies have also approached other vehicle OEMs to get such data.
- However, most OEMs were not comfortable sharing the energy consumption of the PEV components.

[Study]

- This study proposes a method that is vehicle agnostic since it measures the power consumed by the EVSE, at the tip of the EVSE connector.
- In this study **four (4) production BEVs** (Battery Electric Vehicles), with different high voltage battery sizes, have been used to do this energy consumption comparison between L1 and L2 EVSEs.

Preliminary Response of one OEM

- One OEM provided the following rationale to promote L2 EVSEs instead of L1 EVSEs.
 1. OBC (Onboard Charger) is less efficient at lower power and that does affect overall energy consumption from the grid.
 2. The extended charging time for AC L1 adds 12V loads per charging session.
- Find below the example provided by that OEM

| | AC L2 | AC L1 |
|-------------------------------------|-----------|-----------|
| Charge Duration | 2 hrs | 9 hrs |
| Power from wall | 13 kW | 15 kW |
| OBCM output (97% vs. 93% efficient) | 12.610 kW | 14.464 kW |
| 12V loads (282 W/hour) Power | 564 W | 2,538 W |
| Total power into HV battery (same) | 12,046 W | 12,046 W |
| Wasted power due to 12V loads | 0 W | 1,974 W |

Table 1: One OEM data

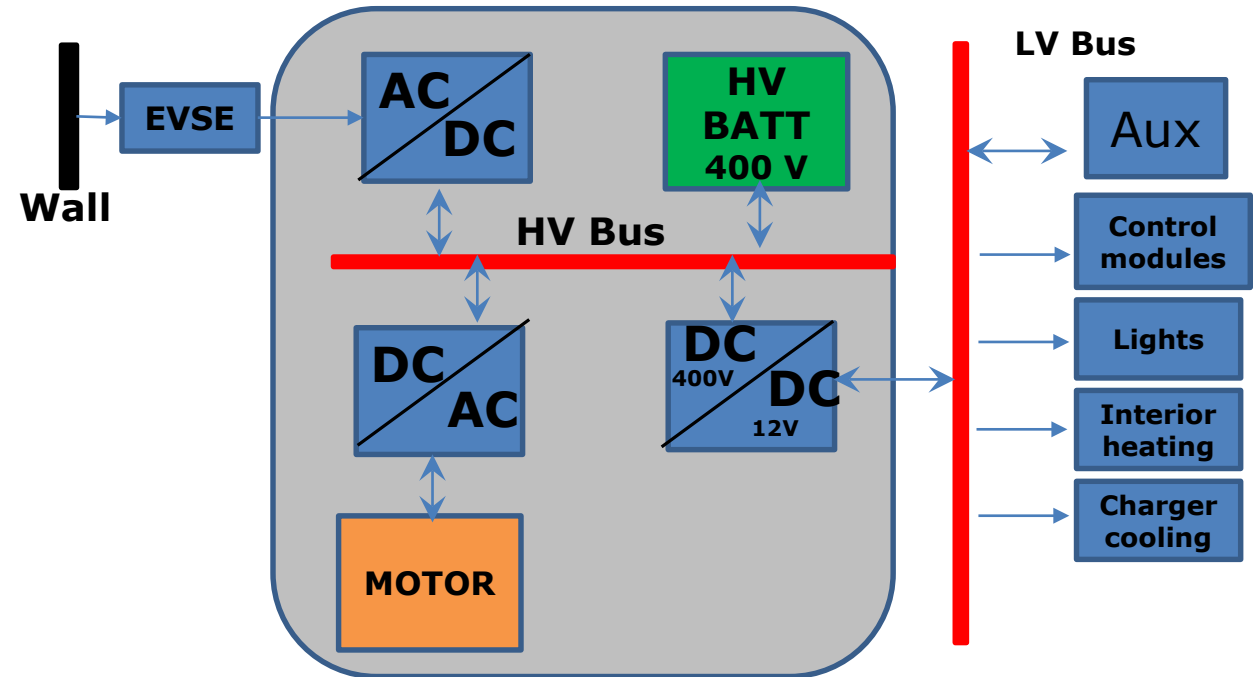

Fig. 1: EV Power flow Block Diagram

Test Procedure & Test Setup

- The following test procedure was conducted:
 - Set the vehicle HV battery SOC at 20%.
 - Charge the vehicle up to 100% SOC.
 - Use a power meter and a **breaker box** to measure the current and voltage at the EVSE connector
- Find below the test setup

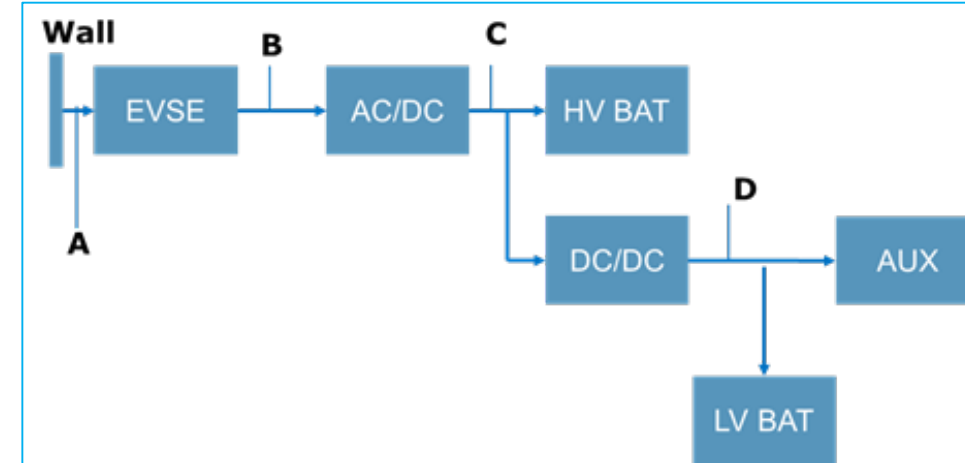

Fig. 2: Efficiency measurement Points



Fig. 3: Test setup

Measurement Point is **B**. A voltage clamp was put at the L-line while current probe were set between L+ and L-.

- 4 production BEVs** have been used for this test:
 - ❖ BEV-A, BEV-B, BEV-C and BEV-D.
- From the power meter we obtained the power consumed through the EVSEs. A 5 minute sampling time was set.
- The trapezoidal integration method of the power was used to obtain the energy consumed. Actually a Riemann method could be also used due to step wise charging profiles.

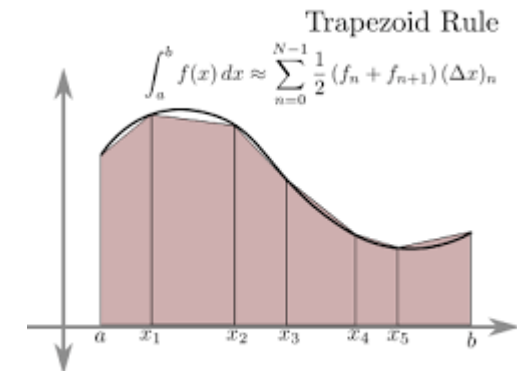
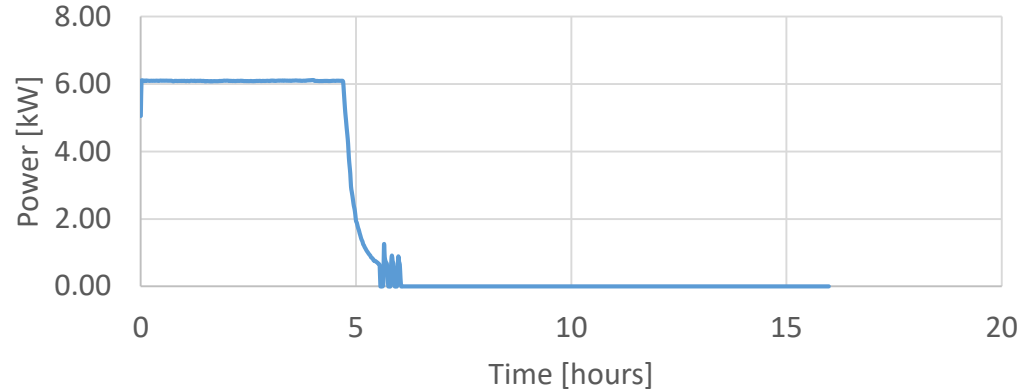

Fig. 4: Trapezoidal method

Test Results of BEV-A



BEV-A L2 Power



BEV-A L2 Energy

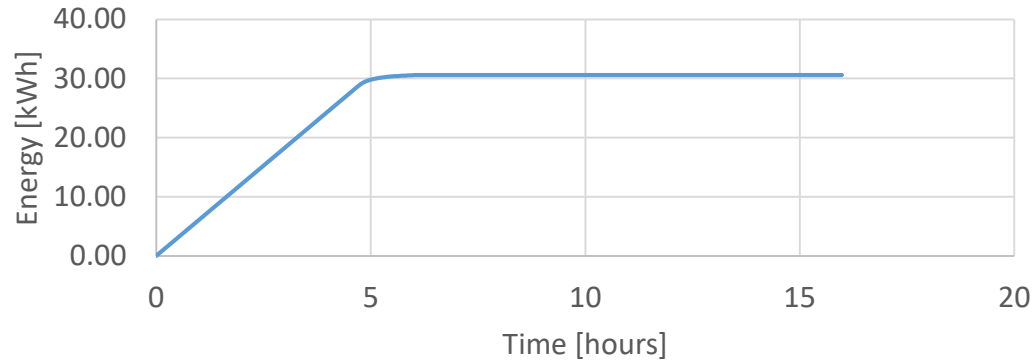

BEV-A L1 Power [kWh]

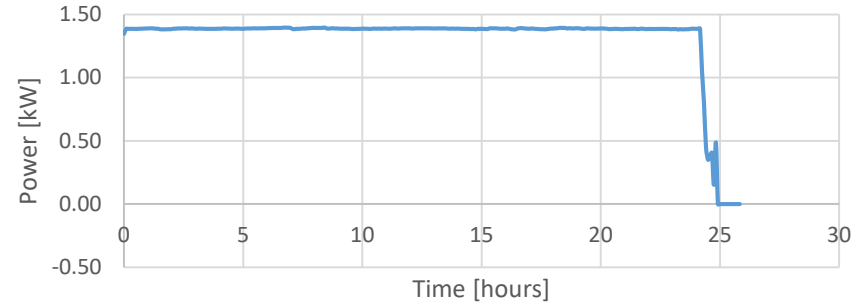

BEV-A L1 Energy [kWh]

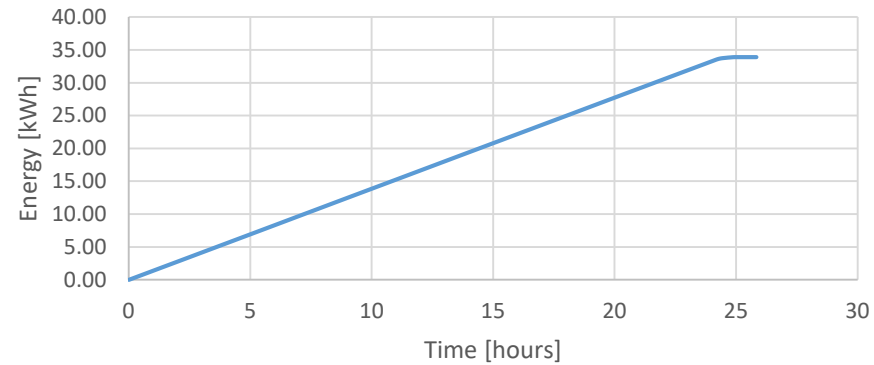

Fig. 5: BEV-A L2 Power and Energy Consumed

Fig. 6: BEV-A L1 Power and Energy Consumed

- ❑ For L2 EVSE 30.57 kWh were consumed over 6 hours.
- ❑ For L1 EVSE 33.90 kWh were consumed over 25 hours.
- ❑ L1 EVSE consumed 3.33 kWh more than L2 EVSE.

Test Results of BEV-B



BEV-B L2 Power [kW]

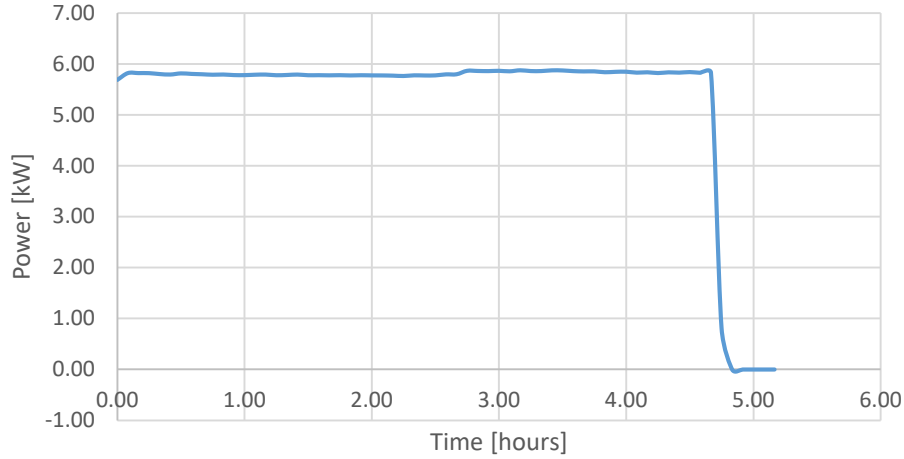

BEV-2 L1 Power [kW]

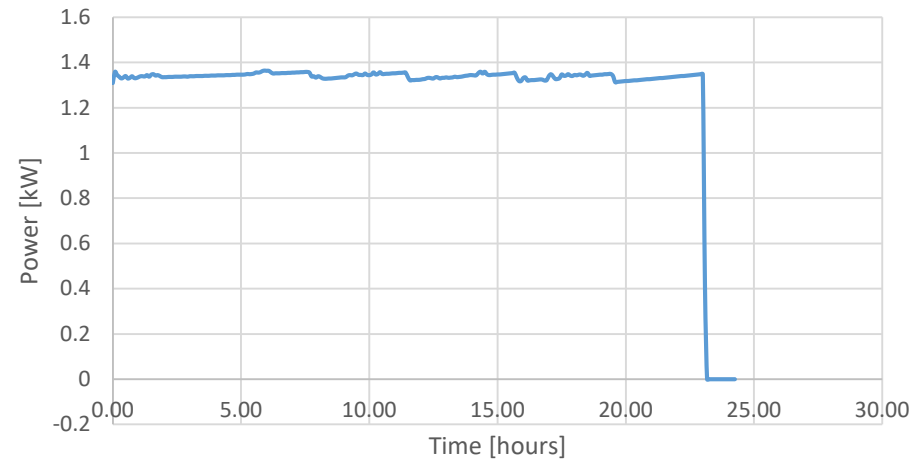

BEV-B L2 Energy [kWh]

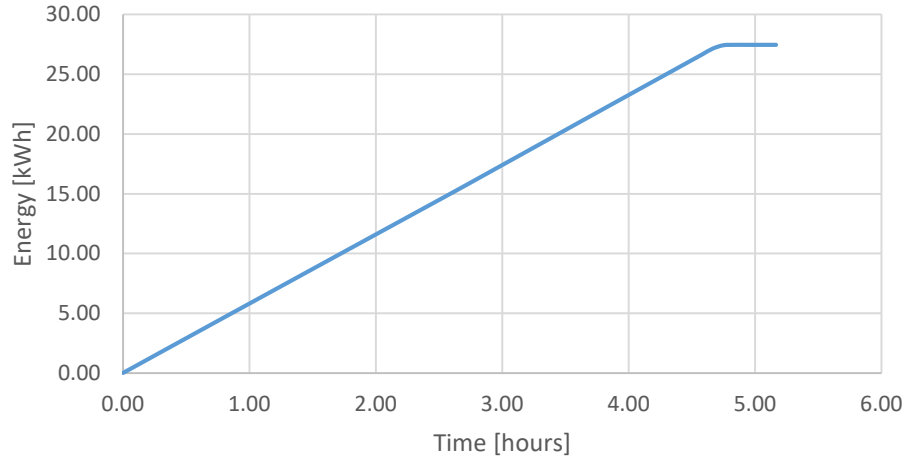

BEV-B L1 Energy [kWh]

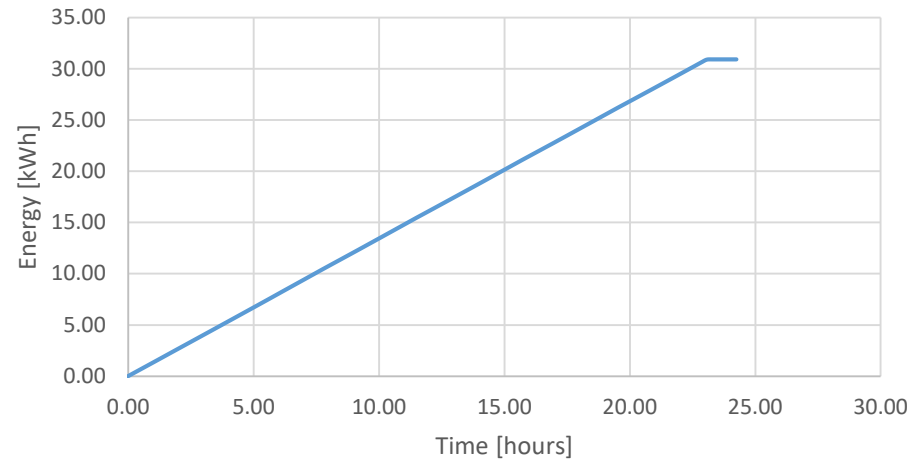

Fig. 7: BEV-B L2 Power and Energy Consumed

Fig. 8: BEV-B L1 Power and Energy Consumed

- ❑ For L2 EVSE 27.46 kWh were consumed over 4.83 hours.
- ❑ For L1 EVSE 30.91 kWh were consumed over 23.17 hours.
- ❑ L1 EVSE consumed 3.45 kWh more than L2 EVSE.

Test Results of BEV-C



BEV-C L2 Power [kW]

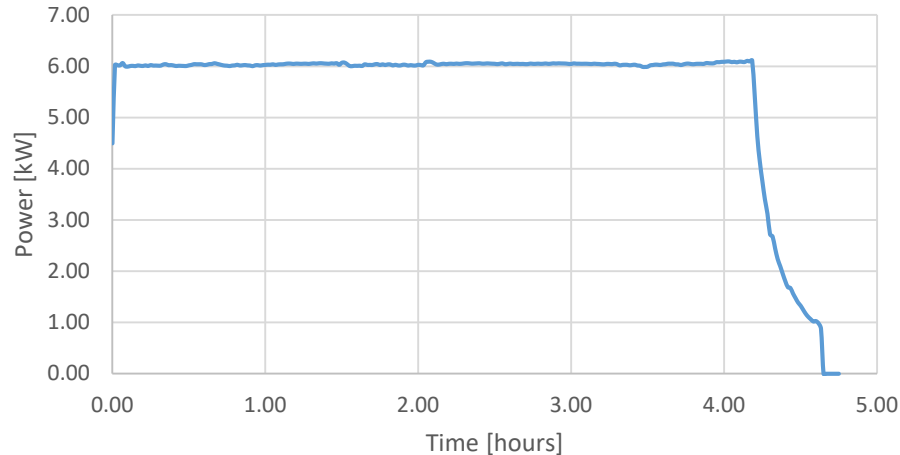

BEV-C L2 Energy [kWh]

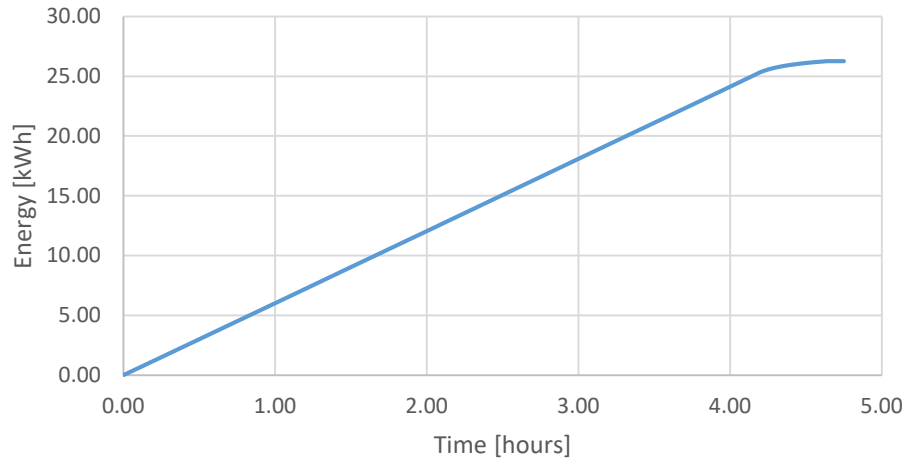
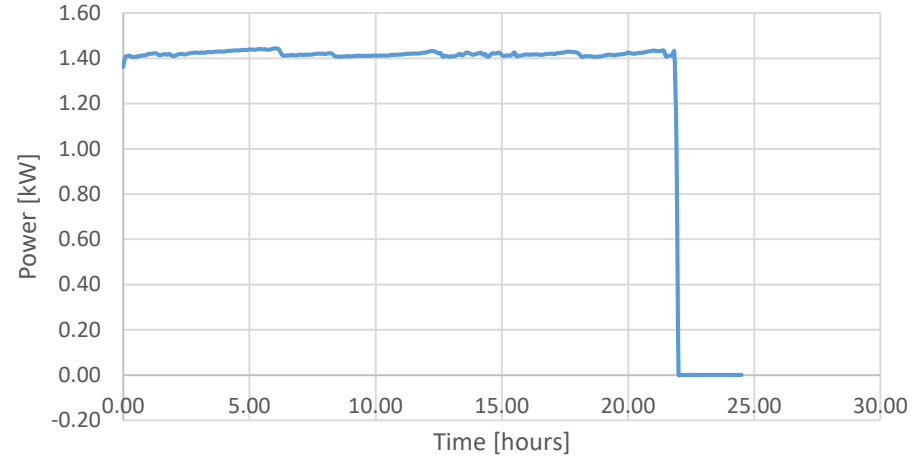

Fig. 9: BEV-C L2 Power and Energy Consumed

BEV-C L1 Power [kW]



BEV-C L1 Energy [kWh]

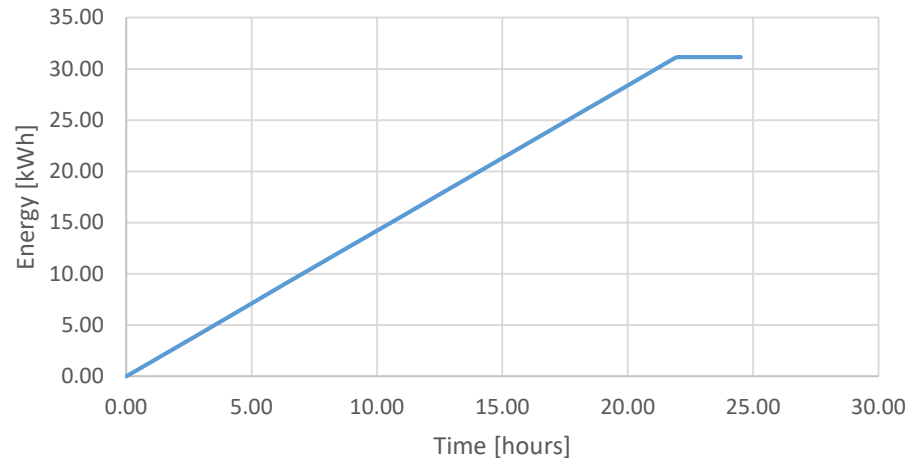
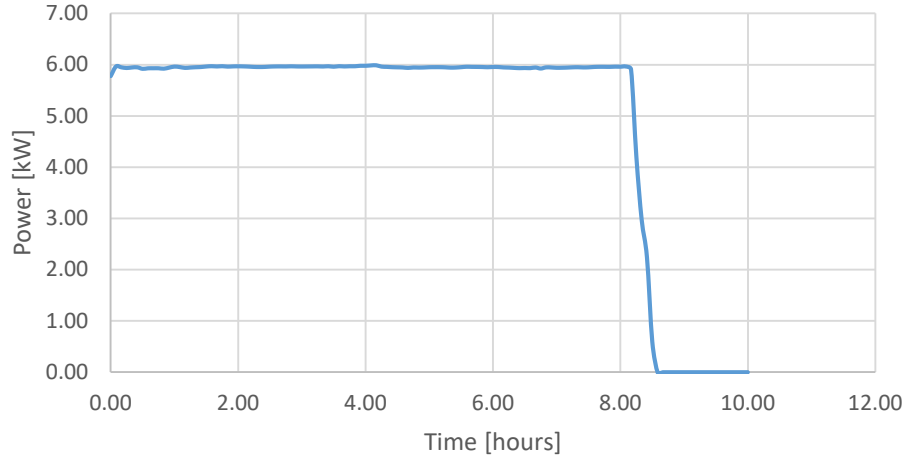

Fig. 10: BEV-C L1 Power and Energy Consumed

- ❑ For L2 EVSE 26.57 kWh were consumed over 4.65 hours.
- ❑ For L1 EVSE 31.14 kWh were consumed over 22 hours.
- ❑ L1 EVSE consumed 4.57 kWh more than L2 EVSE.

Test Results of BEV-D

BEV-D L2 Power [kW]



BEV-D L1 Power [kW]

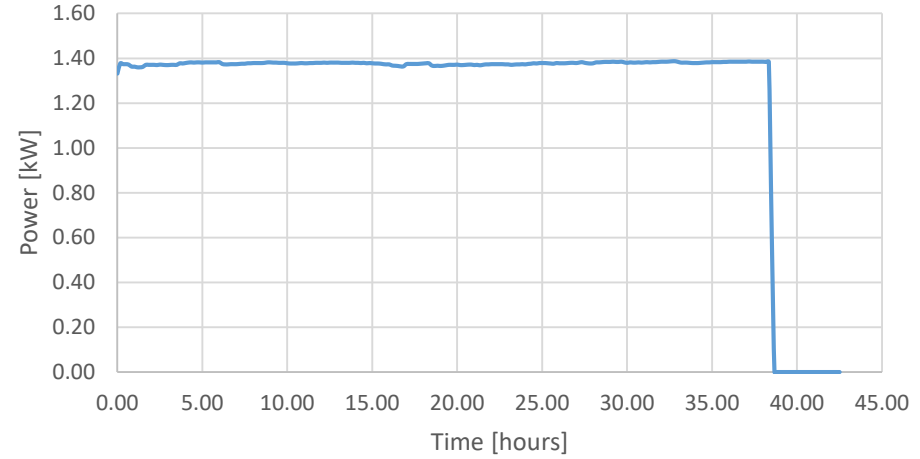

BEV-D L2 Energy [kWh]

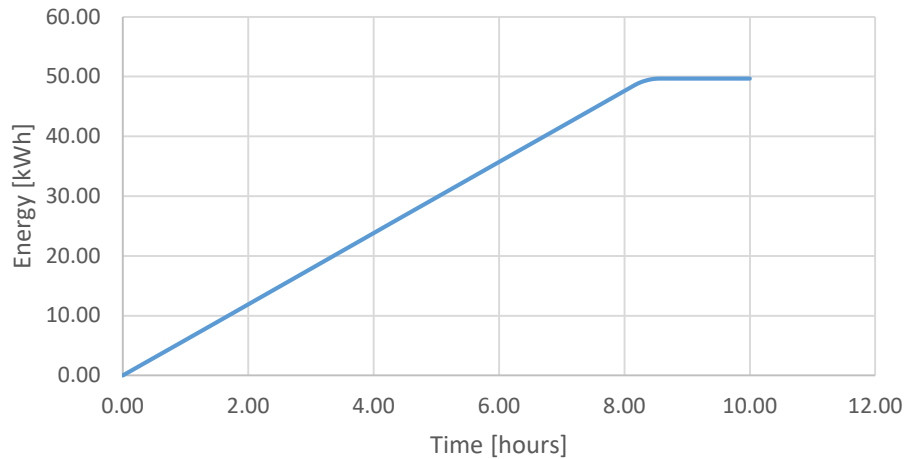

BEV-D L1 Energy [kWh]

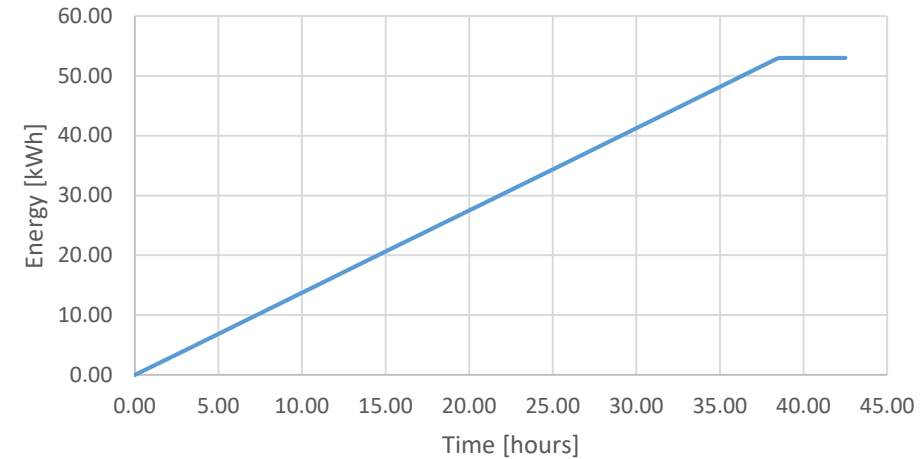

Fig. 11: BEV-D L2 Power and Energy Consumed

Fig. 12: BEV-D L1 Power and Energy Consumed

- ❑ For L2 EVSE 49.68 kWh were consumed over 8.45 hours.
- ❑ For L1 EVSE 53.03 kWh were consumed over 39 hours.
- ❑ L1 EVSE consumed 3.35 kWh more than L2 EVSE.

Summary of Test Results & Conclusions

- Find below a summary of the test results
- L1 EVSE consumes around 7% to 15% more energy than L2 EVSE.

| EV | L1 Energy consumed [kWh] | L2 Energy Consumed [kWh] | Difference [kWh] | (1- L2/L1) [%] |
|-------|--------------------------|--------------------------|------------------|----------------|
| BEV-A | 33.90 | 30.57 | 3.33 | 10% |
| BEV-B | 30.91 | 27.46 | 3.45 | 12% |
| BEV-C | 31.14 | 26.57 | 4.57 | 15% |
| BEV-D | 53.03 | 49.68 | 3.35 | 7% |

Conclusions

- L1 EVSE consumes more energy than L2 EVSE for all the four production BEVs.
- L2 EVSE energy consumption is on average 10% more efficient than L1 EVSE. As a result,
 1. Utility companies will generate less energy for the EV consumers
 2. EV customers can save ~\$60 annually using L2 vs. L1 EVSE
 3. L2 EVSEs are easier for TOU service plan because charging time window is shorter.
- We recommend that Utility and EVSE companies install more L2 EVSEs because of the points above.

END